



# Operating Instructions

Index	Page
<b>Safety instructions</b> .....	<b>02</b>
<b>Operating instructions</b>	
<b>1. Specification</b> .....	<b>03</b>
1.1 Intended use	
1.2 Function	
1.3 Technical data	
1.4 Materials	
1.5 Dimensions	
<b>2. Installation</b> .....	<b>03</b>
2.1 Preparing for use	
2.2 Mechanical connection .....	<b>04</b>
2.3 Electrical connection	
<b>3. Use</b> .....	<b>04</b>
3.1 Commissioning	
3.2 Normal operation	
3.3 Inexpert handling	
<b>4. Maintenance, servicing and spare parts</b> .....	<b>04</b>
4.1 Maintenance	
4.2 Servicing	
4.3 Spare parts	
<b>5. Storage</b> .....	<b>04</b>
<b>6. Disposal</b> .....	<b>04</b>

  
 Depending on the model 

- ▶ **Read these Safety instructions before using the device for the first time and follow the Operating instructions.**

## **Safety instructions**

1. The installation, initial operation and maintenance should only be carried out by a qualified expert with electrical know-how.
2. Comply with the local and statutory rules and/or the VDE0100.
3. Before electrical connection, check the specifications on the data plate and the technical data of this manual.
4. A fuse must be connected in series to the supply voltage, according to the Standard and Normative documents.
5. Protect the signal contacts of the limit switch against voltage peaks when inductive or capacitive loads are connected.
6. The device may be put into operation only if the protection made of Porexpan and placed inside the housing has been removed. This is only a protection during the transport of the device.
7. The device may be put into operation only if the electrical connection is correct. To secure the type of protection, the sealing cap and the gasket must be placed correctly and the screw nut of the cable gland has to be fixed and fastened to the cable entry.
8. The earth connection of the device has to be installed in such a way that mechanical damage will be excluded.
9. Protect the controller from vibration and shakes. The vibration can provoke premature damage to the controller and may become useless.
10. The blade must not be hit by the filling stream. To avoid this, deflect the filling stream or install a deflection screen or a protection roof. It is also recommended to install a protection roof when the controllers are used as empty-indicator or medium-indicator in silos where vaults could be formed or where high loads above it could exist.
11. Avoid the installation of standard devices in ambient with vapour or with several changes of temperature. There are specific models for these applications with different sealings rings and bearings that can extend the lifetime of the device.
12. Ask for rotary levels with the special sealing ring made of Stainless Steel-PTFE-Viton in applications with aggressive products or with micronized bulk solids.
13. The connections of the single components as like as blade, shaft, extension, anti-buckling protection, etc. are permissible only with the attached pins.
14. Switch off the power supply, before disconnecting the device.

## Operating instructions

### 1. Specification

#### 1.1 Intended use

The rotary blade level indicator IRP observes the filling level as a limit switch. It can be used as indicator for dusty and powdery, granulated and grainy bulk goods like dust, flour, grain, sand, plastic, etc. with a grain size up to 20 mm, bulk density up to 1 t/m<sup>3</sup> and a height of product up to 5 meters.

Higher densities and higher height of products to be consulted.

#### 1.2 Function

The rotating measuring blade, projecting into the silo or container, is driven by a gearmotor. If the bulk material reaches the measuring blade, the rotation will be hindered and it will be stopped. The return torque turns the pivoted motor from its end position and actuates the signal switch. A second switch turns off the motor off.

If the filling level of the bulk material sinks, the blade becomes freely again and a spring will turn the motor back into its original end position. Thereby the motor will be turned on again and the signal switch will be switched back.

#### 1.3 Technical data

<b>Manufacturer</b>	Talleres Filsa, S.A.U.
<b>Address</b>	Bernat Metge, 33 08100 Mollet del Vallès (Barcelona)
<b>Name</b>	Rotary blade indicator
<b>Type</b>	<b>IRP</b> ref: 2110-... <b>IRP Retén</b> ref: 2111-...
<b>Measuring blade speed</b>	5 rpm
<b>Switching voltage</b>	Standard 230 V AC (50 ... 60 Hz) (Under request 115 V AC, 48 V AC, 24 V AC, 24 V DC due to a converter)
<b>Power consumption</b>	3 VA en AC; 3 W en DC
<b>Density of the product</b>	0.01 t/m <sup>3</sup> ... 1 t/m <sup>3</sup>
<b>Maximum pressure</b>	-0.5 bar ... +0.5 bar (Under request up to +1 bar with sealing ring of Stainless Steel-PTFE-Viton)
<b>Cably entry</b>	2 of M20x1.5
<b>Maximum voltage of contact</b>	250 V AC
<b>Switching function</b>	1 NO + 1 NC
<b>Capacity of the contact</b>	2 A / 250 V AC (for resistive loads)
For inductive or capacitive loads reduce at 50%	
<b>Ambient temperature</b>	-20 °C ... +60 °C
<b>Protection</b>	IP65 according DIN EN60529
<b>Weight</b>	0.8 kg depending on the model

#### 1.4 Materials

<b>Housing and cap</b>	Glass reinforced ABS
<b>Flange connection and</b>	Aluminium or Stainless Steel
<b>Nut (Under request)</b>	Zincated Steel or Stainless Steel
<b>Measuring blade</b>	S.S. 1.4301, shaft 1.4305 (Under request special models of S.S. 1.4401 or Plastic)

#### Sealing ring

<b>IRP</b>	NBR
<b>IRP-R</b>	Stainless Steel-PTFE-Viton

#### Rod shaft

Stainless Steel

#### Protection tube shaft

Zincated Steel

(Under request Stainless Steel)

#### 1.5 Dimensions

Approximate measures are given in mm.

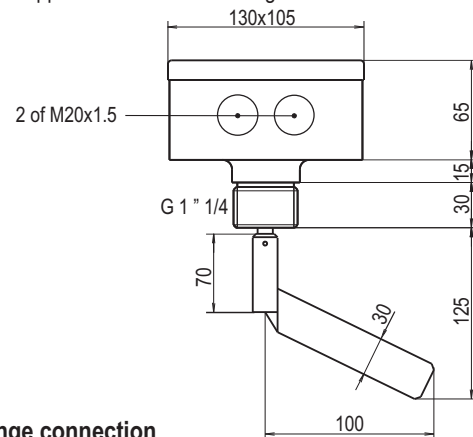

#### Flange connection

Under request. Threaded flange in all models G 1 " 1/4 female.

IRP-001

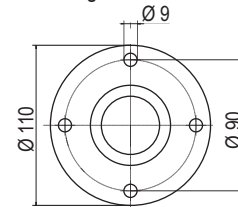

#### A-25-110

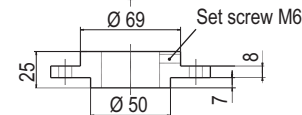

IRP-002

#### A-50-110

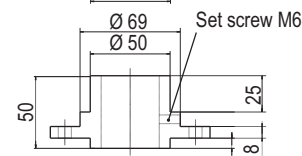

IRP-003

#### I-25-110

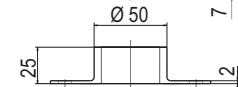

IRP-004

#### I-50-110

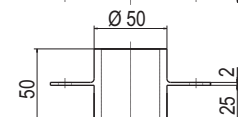

IRP-005

## 2. Installation

### 2.1 Preparing for use

- Read the Safety instructions and the Operating instructions before using the controller.
- Verify if you got all the parts, the controller, blade with pin and shaft extension if it was requested.

## 2.2 Mechanical connection

There are models that can be mounted horizontally or vertically into the silo.

The standard form is mounting the device with a flange, drilling holes on the silo to allow the mounting of the controller using screws, rods, fasteners or nuts. If the flange was not requested, the thread is 1 " 1/4 or 1 " male, depending on the model and can be fixed using 1 or 2 nuts or introducing it into a threaded socket with a maximum of 25 mm length. If it is larger, the bulk goods have the possibility to deposit in the thread socket. This could provoke that the device becomes useless.

### Protection roof

The blade must not be hit by the filling stream. To avoid this, deflect the filling stream or install a deflection screen or a protection roof. It is also recommended to install a protection roof when the controllers are used as empty-indicator or medium-indicator in silos where vaults could be formed or where high loads above it could exist.

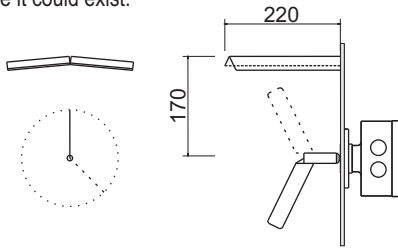

IRP-006

## 2.3 Electrical connection

### Connection diagram AC

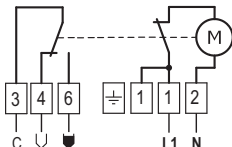

IRP-007

### Connection diagram DC

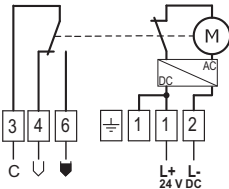

IRP-008

- ⊕ - Ground
- 1 - Supply AC / - Positive: 24 V DC
- 2 - Supply AC / - Negative: 0 V DC
- 3 - Common
- 4 - Normally closed
- 6 - Normally open

### Cable gland

- Fasten the cable gland after making the electrical connection.
- Fix and fasten the screw nut of the cable gland to make sure of the water-tightness.

## 3. Use

### 3.1 Commissioning

- Put the controller into operation only if the installation and the electrical connection have been done correctly.
- The device may be put into operation only if the protection made of Porexpan and placed inside the housing has been removed. This is only a protection during the transport of the device.

### 3.2 Normal operation

- Use the device in its intended application only.
- Comply with the specifications on the data plate and the technical data of this manual.
- If the controller is damaged, disconnect it immediately.
- It is forbidden to make changes to the device. This violates the Normative.

### 3.3 Inexpert handling

- Ignoring the Safety instructions and the Operating instructions.
- Not intended use.
- Making changes or handling the controller.
- Violation against applicable Law and Standards.
- Using of non original parts.

## 4. Maintenance, servicing and spare parts

### 4.1 Maintenance

- If used correctly, no specific maintenance is required.

### 4.2 Servicing

- Check and review the state of the housing, the blade, shaft extension if it was required and the correct commutation of the electrical contact, as well.

### 4.3 Spare parts

- Use only original parts.
- The spare parts of the controller can be consulted in the document "R-IRP-01".

## 5. Storage

- Store the controller in a dry and dust-free environment.
- Dismount the shaft together with the blade. Ensure that the shaft of the level indicator with jib extension will not be buckled or bended.

## 6. Disposal

- Switch off the power supply, before disconnecting the device.
- The controller can be recycled.
- The disposal applies to the valid environmental Guidelines according to the location of the carrier and the local manufacturing conditions.

FILSA constantly strives to improve its products and reserves the right to modify designs, materials and data without prior notice.